

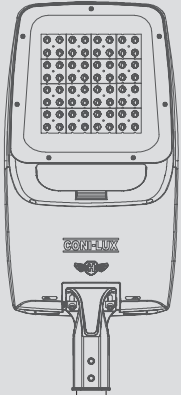

CLEO20/23

LED street light





CERTIFICATE

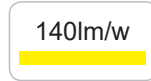

PRODUCT SPECIFICATION

Item	Cleo20/23					
Power	50W	80W	100W	120W	150W	200W
Efficiency	>140lm/w					
Lumen output	≥7000lm	≥11200lm	≥14000lm	≥16800lm	≥21000lm	≥28000lm
Led chips	Philips lumileds 3030					
CRI	>80					
Life span	60,000hrs at Ta=25deg, L70/B10					
Color Temperature	2700K-6500K					
Optic lens	PC Lenses					
Driver	Philips Xi-LP series(Meanwell/Inventronic/Osram upon request)					
Input Voltage	100~305 VAC (Depending on driver model) 47~63 Hz					
Power factor	>95%					
THD	<10%					
Protection level	CLASS I					
SPD	10KV (optional 20KV or other)					
Housing	aluminum by die-casting					
Finish	powder coating					
Housing color	●RAL 7035 ●RAL7024 (others upon request)					
IP Rating	IP66					
IK Rating	IK09					
Mounting	Horizontal or vertical on 60mm pipe, installation agnle canbe adjustable (0-15deg)					
Working Temperature	-30°C ~ + 65°C					
Warranty	5 years					



LUXEON 3030 2D Line

High flux,
hot-color targeted 6V package

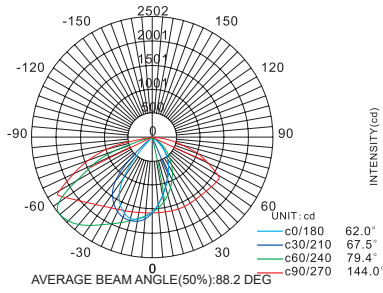
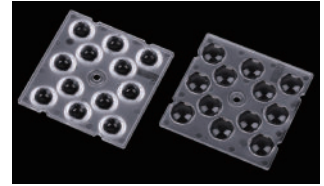

TYPE I

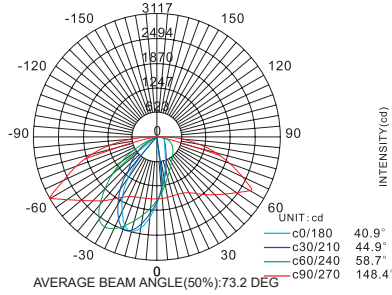

TYPE II

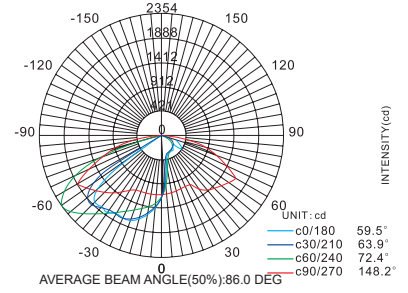

TYPE III

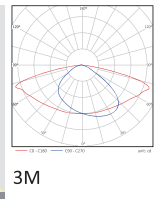
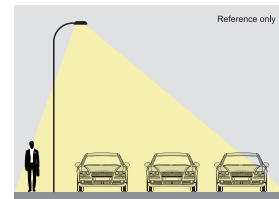
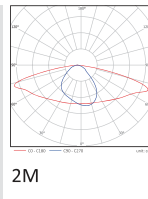
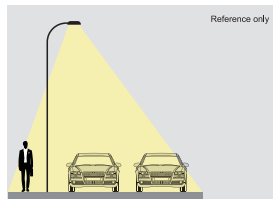
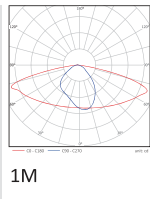
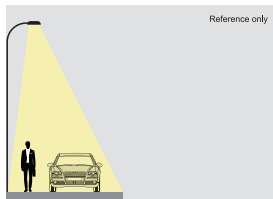

192



256

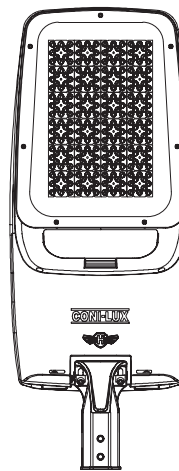

288

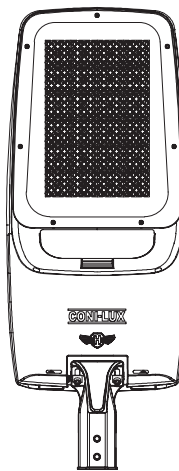

384

Cleo20/23-mini(3030)
Zhaga Optic lens : 16pcs

Cleo20/23-maxi(3030)
Zhaga Optic lens : 24pcs



LUXEON 5050

Highefficacy and lumens in a multi-die, high power package, enabling low system costs

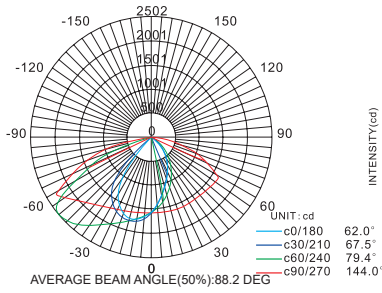

TYPE I

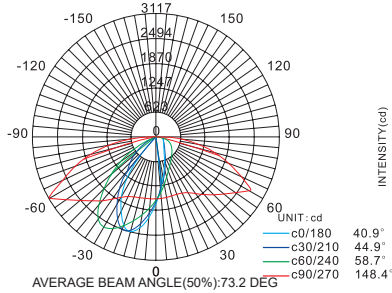

TYPE II

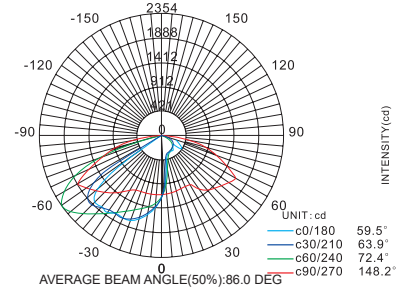

TYPE III



64



96



128

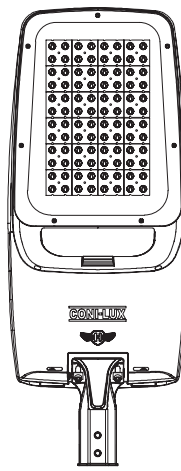

96

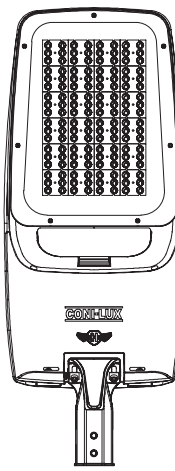

144

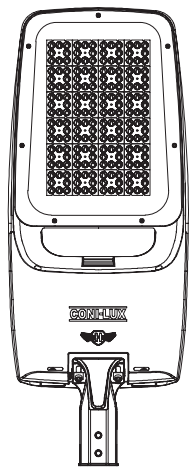

192

Cleo20/23-mini(5050)
Zhaga Optic lens : 16pcs

Cleo20/23-maxi(5050)
Zhaga Optic lens : 24pcs

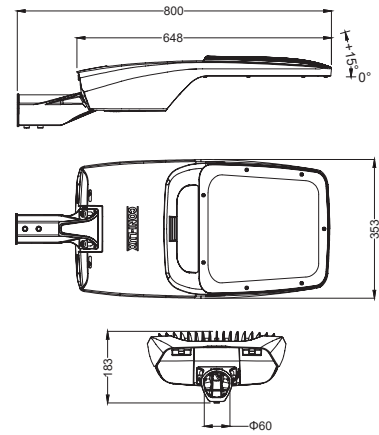

Cleo20/23-mini

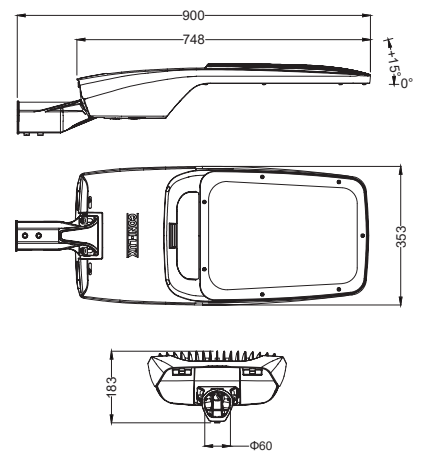

Cleo20/23-maxi

- 
 URBAN &
RESIDENTIAL
STREETS
- 
 BRIDGES
- 
 BIKE &
PEDESTRIAN
PATHS
- 
 RAILWAY
STATIONS &
METROS
- 
 CAR PARKS
- 
 SQUARES
& PEDESTRIAN
AREAS

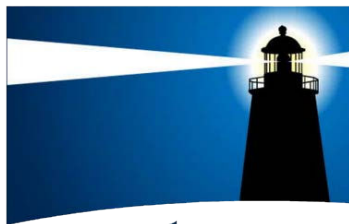

Cleo20/23 LED street light Specification

מגדל אור

ה נ ד ס ת ת א ו ר ה

LED street light series



VERSION	RECOMMENDED MOUNTING HEIGHT(METERS)
Cleo20/23-mini	4-8M
Cleo20/23-maxi	6-12M



MIGDAL-OR LIGHTING ENG. CO.,LTD.
Together for Brighten Future

Tel: +972-4-8525244

Fax: +972-4-8525245

E-mail: office@migdal-or.org

www.migdal-or.org