

CLEO-20/24 Series

STREET LIGHT

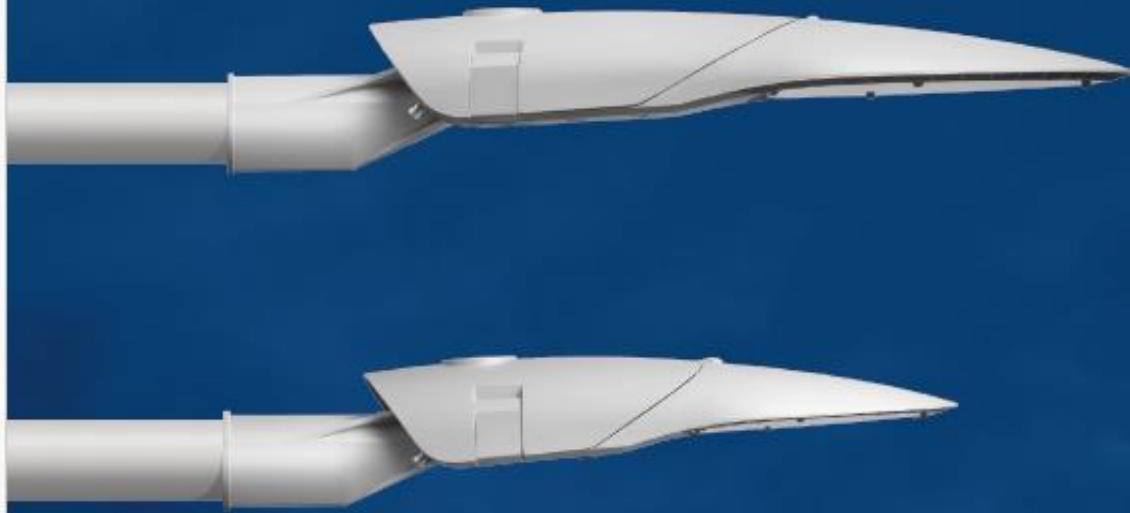

WWW.MIGDAL-OR.ORG
office@migdal-or.org
טל. 04-8525244 , פקס. 04-8525245





CLEO MAXI



CLEO MINI

Migdal-or Lighting Eng.

TEL. 04-8525244
FAX. 04-8525245
office@migdal-or.org
www.migdal-or.org

CLEO-20/24 MINI
STREET LIGHT



No.LED	POWER(W)	Luminous flux of the luminaire(lm) -4000k(T)=85°C)
72	30	4200
	50	6750
	60	7800
	70	8750
120	60	8400
	75	10125
	90	11700
160	100	12500
	80	11200
	90	12150
	100	13000
180	120	15000
	100	14000
	120	16200
216	150	19500
	180	22500
	120	15000
280	150	18000
	180	20700
	200	22000
280	150	18750
	180	21600
	200	23000
	250	27500

CLEO-20/24 MAXI
STREET LIGHT



No.LED	POWER(W)	Luminous flux of the luminaire(lm) -4000k(T)=85°C)
24	30	4350
	50	7000
	60	8100
	70	9100
40	60	8700
	75	10500
	90	12150
	100	13000
60	80	11600
	90	12600
	100	13500
	120	15600
80	90	13320
	100	14300
	110	15180
	120	15960
72	100	14800
	120	17160
	135	18630
	150	19950
108	120	17400
	150	21000
	180	24300
	200	26000
144	150	21750
	180	25200
	200	27000
	250	32500

Product Dimension

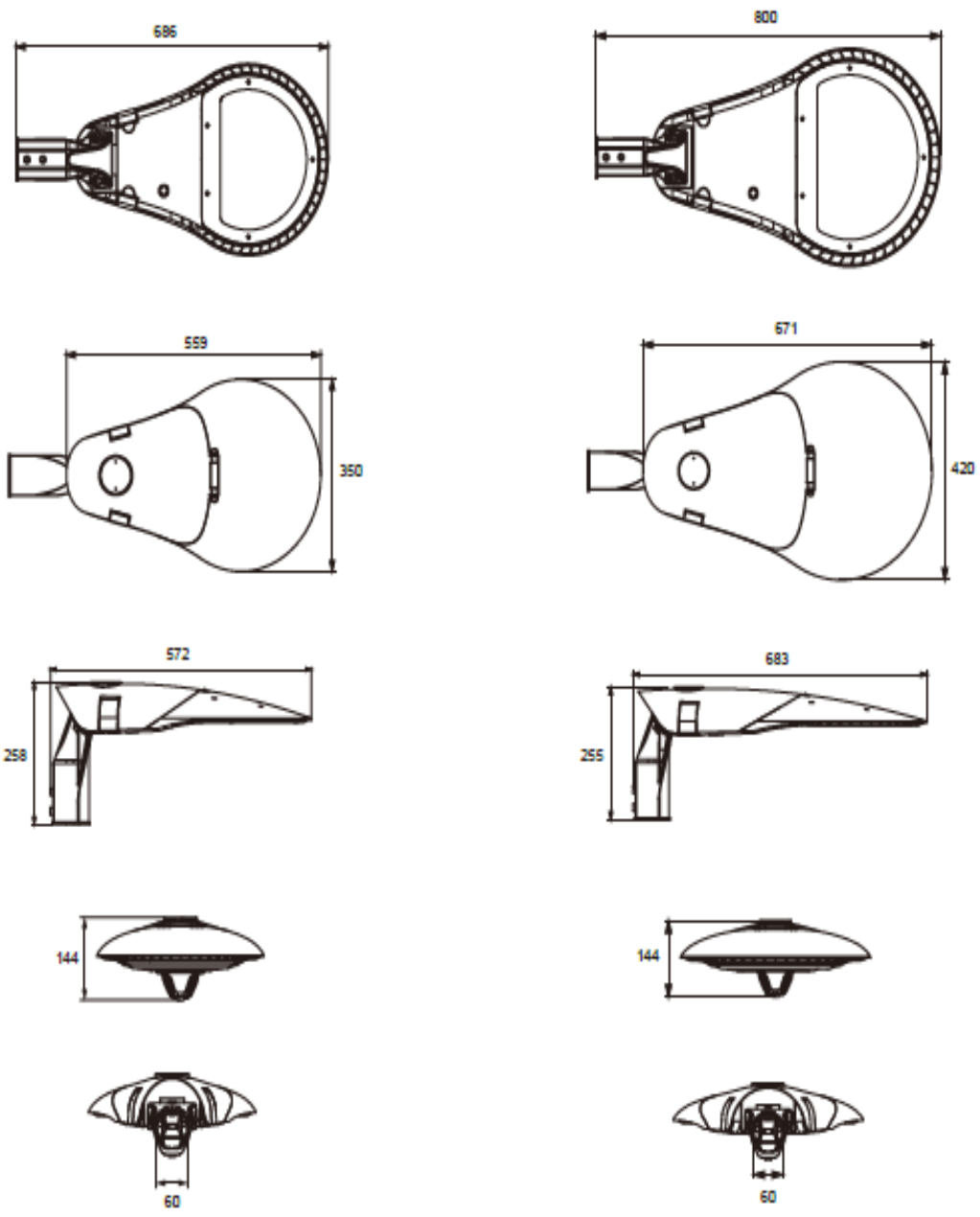

CLEO MINI

CLEO MAXI



Product features

Product Name:	RAW SERIES
Power:	60W~300W
Supply voltage range:	100-305VAC
Temperature range:	-25°C / +55°C
Light guiding system:	PC lenses
Light source:	LUXEON 3030 / LUXEON 5050
Luminous intensity class:	Asymmetrical: G1
Glare Index class:	D6
Colour temperature:	2700K-6500K
Colour Rendering Index:	CRI>80
System efficacy:	≥125 lm/W
LED Lifetime:	MIN 50,000 hours
Power Efficiency:	≥92%
Lightning protection:	10KV
Housing material:	Die-cast aluminum
Sealing material:	Silicone rubber
Cover material:	Tempered glass
Housing colour:	Light Grey,Dark Grey,Black(or specified color)
Protection class:	IP66
Shock protection:	IK09
Corrosion resistance:	C5
Mounting diameter option:	Ø60mm
Net weight :	"MINI : 5.56 KG / MAXI : 7.11KG"

Luxeon 3030

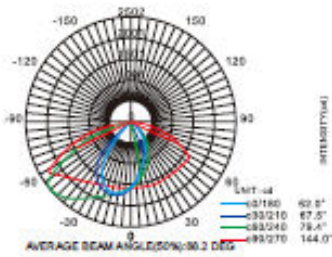

TYPE I

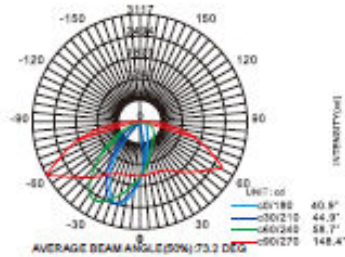

TYPE II

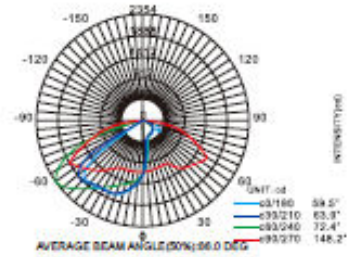

TYPE III

Luxeon 5050

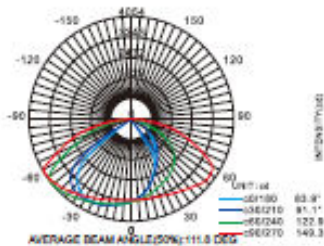
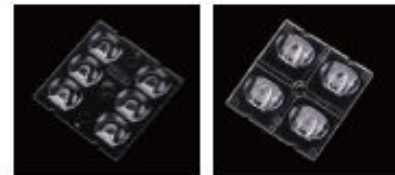

TYPE II

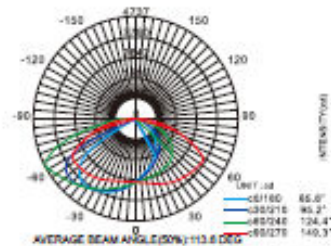

TYPE III